

403.50MHz SAW Filter

Model: TA0489A

Part No: MA09370

REV NO.: 2

A. MAXIMUM RATING:

1. Input Power Level: 10 dBm
2. DC voltage: 3 V
3. Operating Temperature: 32°C to 42°C
4. Storage Temperature: -40°C to +85°C

B. ELECTRICAL CHARACTERISTICS:

Item			Min.	Typical	Max.	
Center frequency	F _c	MH	-	403.5	-	
Insertion loss	402 ~ 405 MHz IL	dB	-	1.85	3.0	
Amplitude ripple	402 ~ 405 MHz	dB	-	0.45	1.3	
VSWR	402 ~ 405 MHz			1.5	2.0	
Attenuation (Reference level from 0 dB)						
	303.5 ~ 358.5	MHz	dB	40	65	-
	358.5 ~ 388.5	MHz	dB	35	53	-
	423.5 ~ 448.5	MHz	dB	35	47	-
	448.5 ~ 503.5	MHz	dB	40	61	-
	Temperature coefficient of frequency	ppm/k	-	-37	-	
Source impedance	Z _s	Ω	-	50	-	
Load impedance	Z _L	Ω	-	50	-	

Note1. No matching network required for operation at 50 Ω

C. MEASUREMENT CIRCUIT:

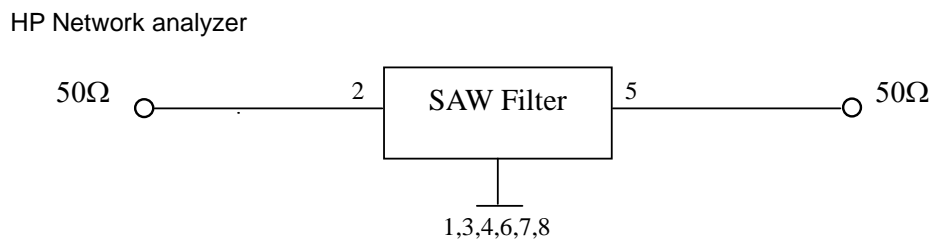

403.50MHz SAW Filter

Model: TA0489A

Part No: MA09370

REV NO.: 2

D. FREQUENCY CHARACTERISTICS:

Transfer Function

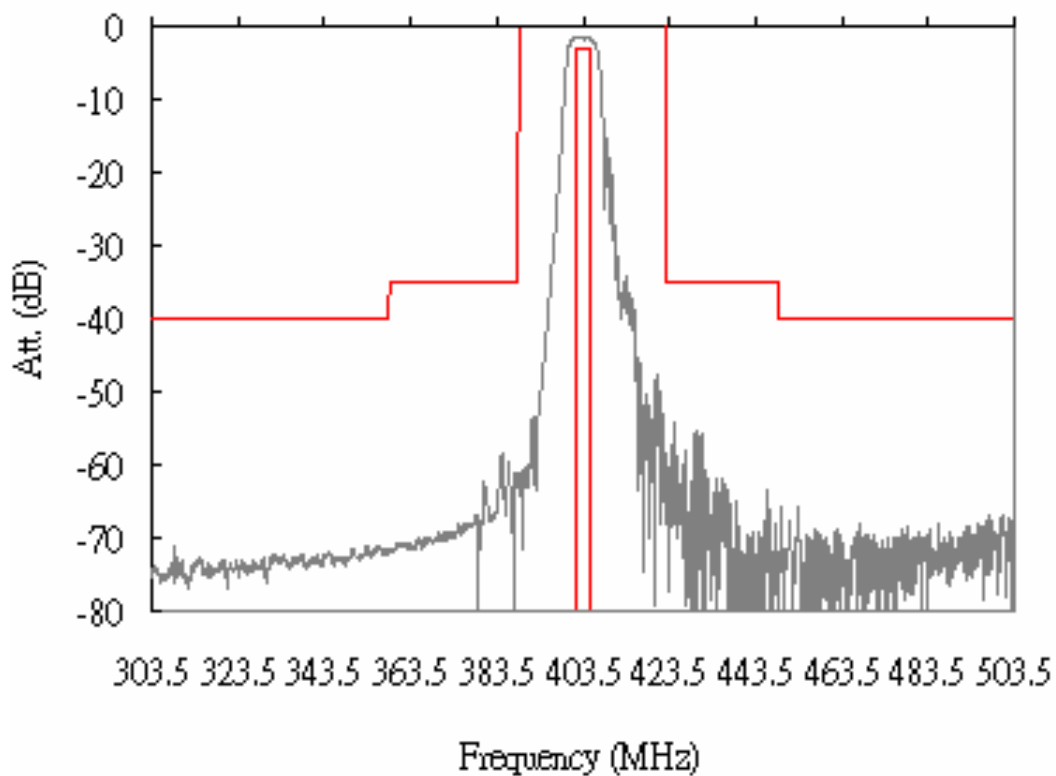
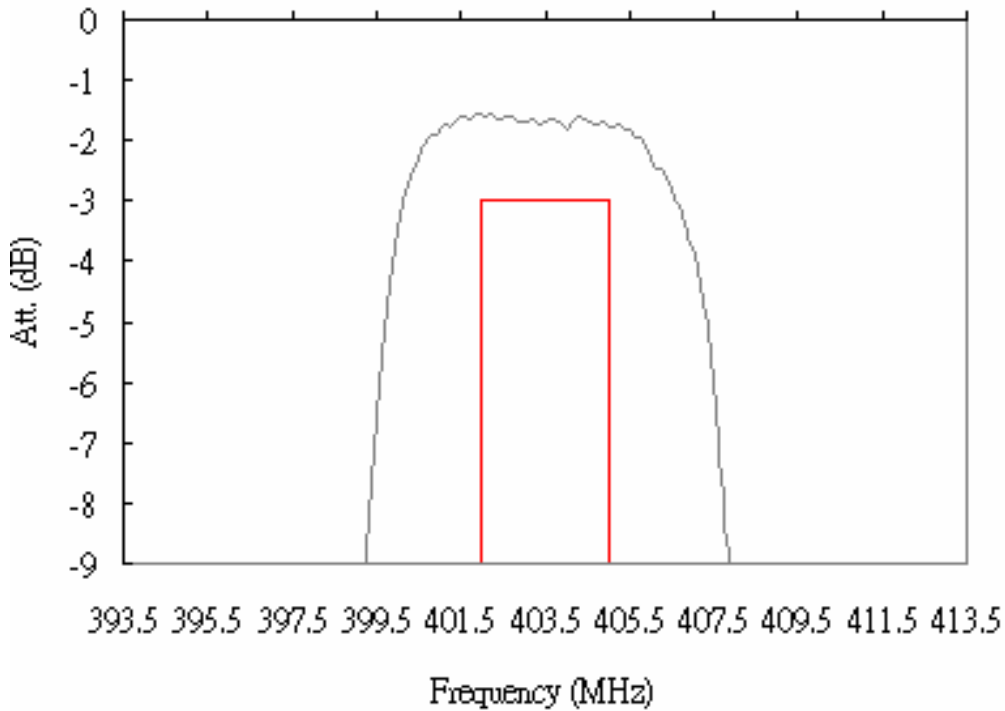

403.50MHz SAW Filter
Part No: **MA09370**

Model: **TA0489A**
REV NO.: 2

Reflection Function

S11

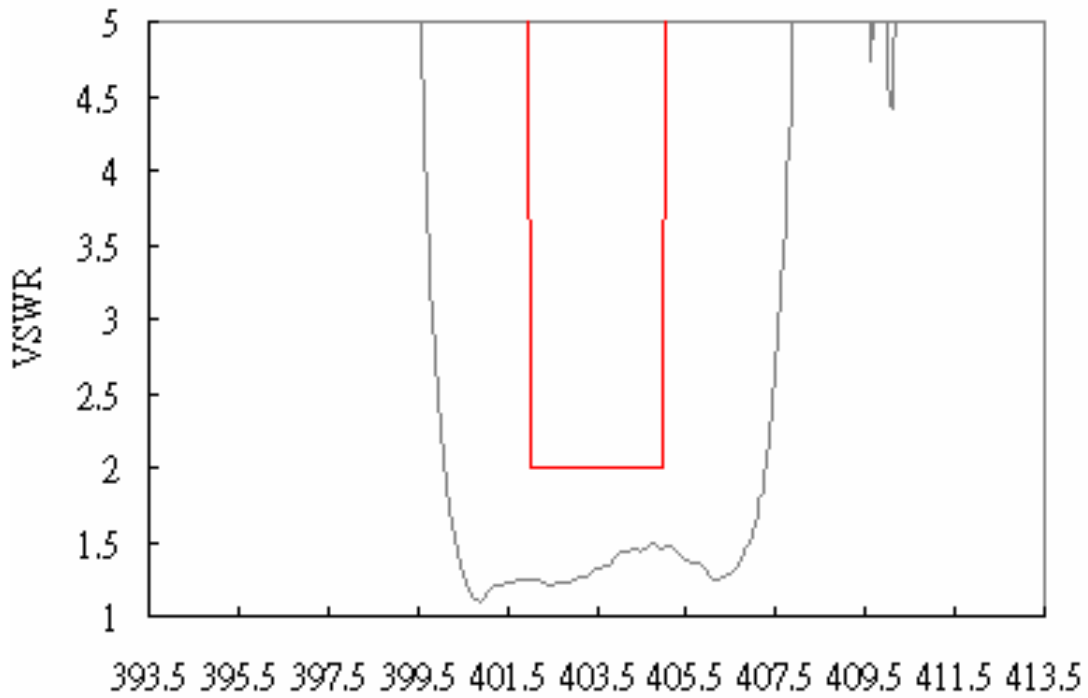

S22

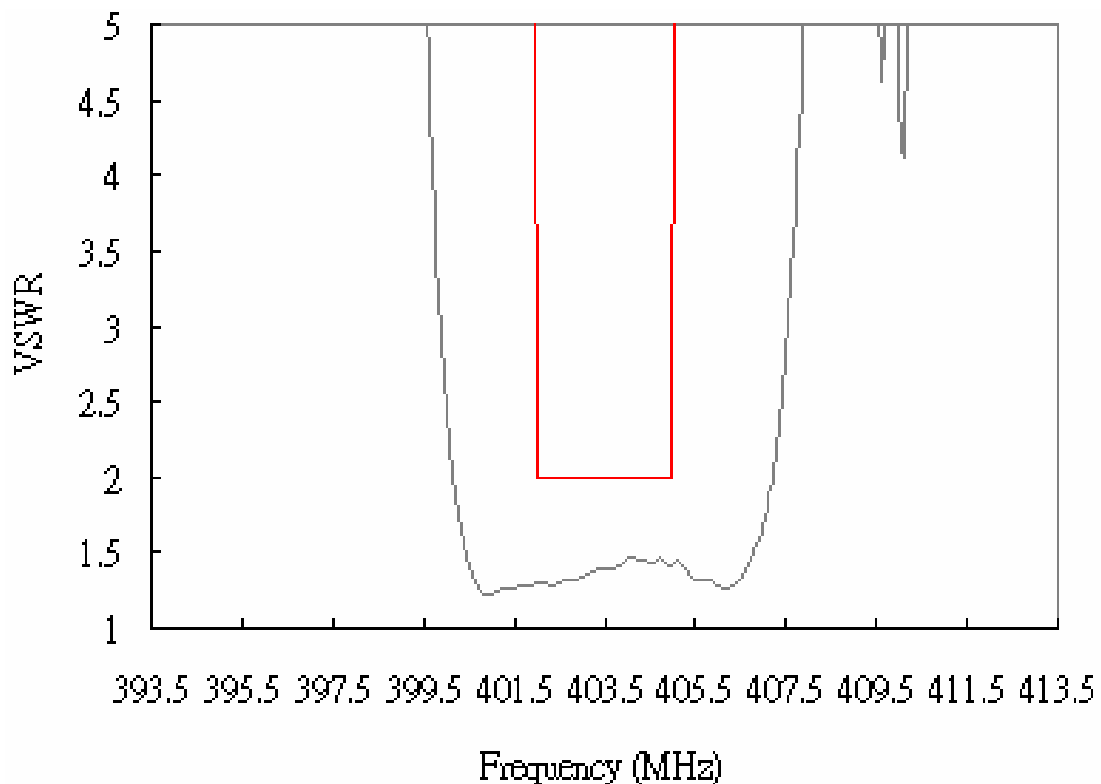

403.50MHz SAW Filter

Model: TA0489A

Part No: MA09370

REV NO.: 2

E. OUTLINE DRAWING:

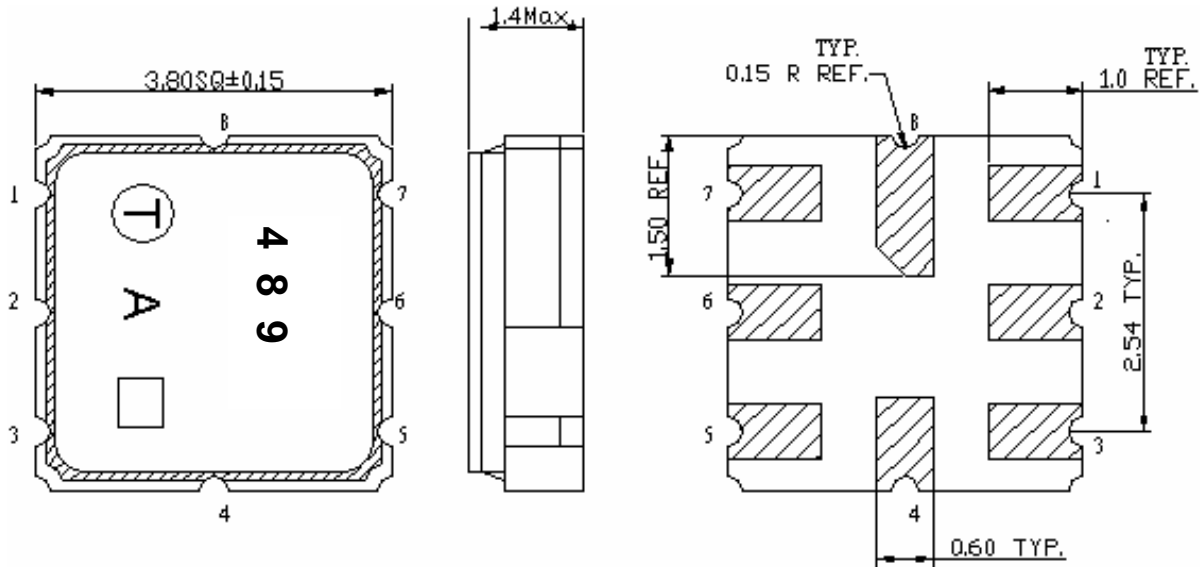

2 : Input
 5: Output
 1,3,4,6,7,8: Ground
 Unit: mm

F. PCB FOOTPRINT:

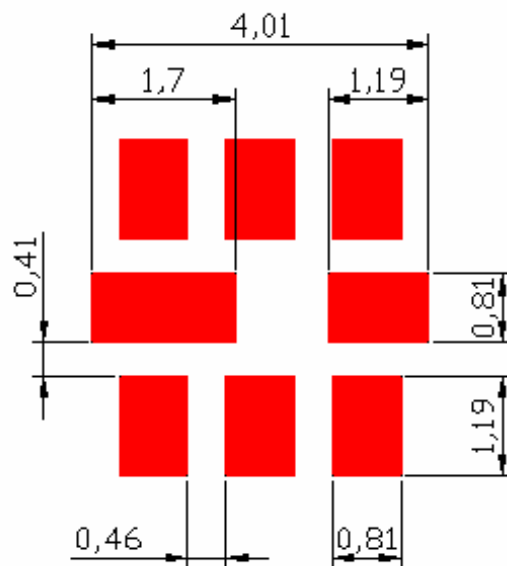

403.50MHz SAW Filter
Part No: **MA09370**

Model: **TA0489A**
REV NO.: 2

G. PACKING:

1. REEL DIMENSION

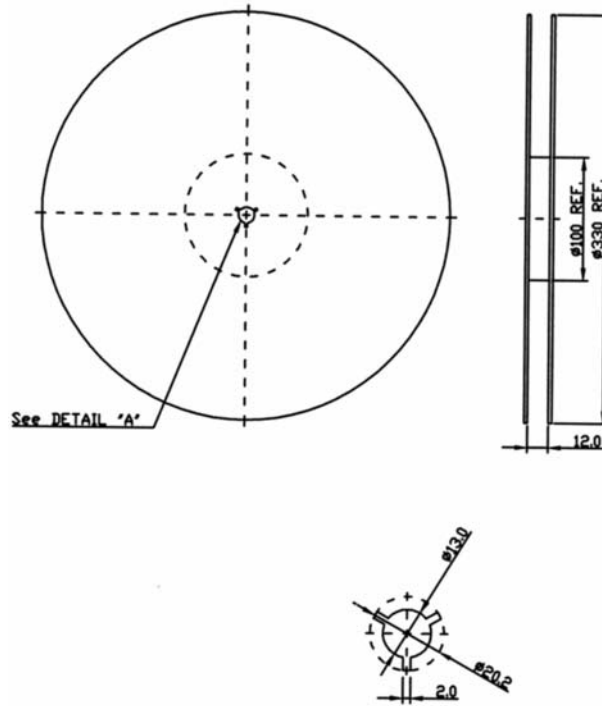

2. TAPE DIMENSION

