

**SAW Filter 441.0MHz**  
**Part No: MA07507**

**Model: TA0419A**  
**Rev No: 1**

**A. MAXIMUM RATING:**

1. Input Power Level: 10dBm
2. DC voltage: 3V
3. Operating Temperature: 0°C to +50°C
4. Storage Temperature: -40°C to +85°C

**B. ELECTRICAL CHARACTERISTICS:**

Reference temperature: 25°C

Item	Unit	Min.	Typ.	Max.
Center frequency Fc	MHz	-	441	-
Insertion Loss IL min (reference level)	dB	-	1.5	2.8
2dB Bandwidth BW -2dB	MHz	19	22.3	-
Absolute Attenuation: (Reference level from 0dB)				
Fc -45 to Fc -100MHz	dB	40	56	-
Fc +45 to Fc +55MHz	dB	30	56	-
Fc +55 to Fc +100MHz	dB	40	54	-
Temperature coefficient of frequency	ppm/k	-	-36	-
Source impedance Z <sub>S</sub>	Ω	-	50	-
Load impedance Z <sub>L</sub>	Ω	-	50	-

Note:

IL min is the minimum of the pass band attenuation. The center frequency Fc is the mean value of the upper and lower frequencies at the 2dB filter attenuation level relative to the IL min.

**SAW Filter 441.0MHz**  
**Part No: MA07507**

**Model: TA0419A**  
**Rev No: 1**

**C. FREQUENCY CHARACTERISTICS:**

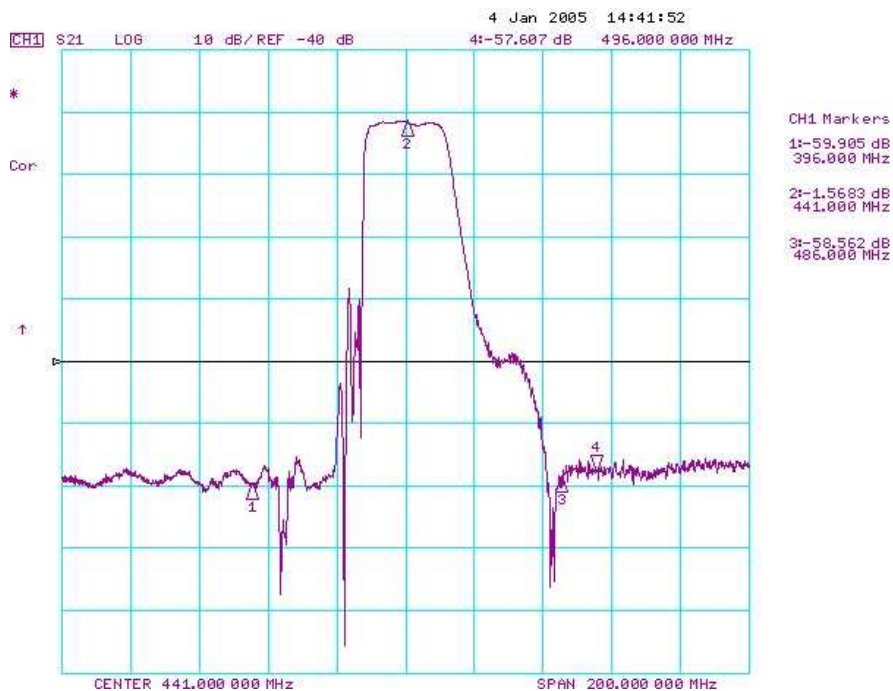
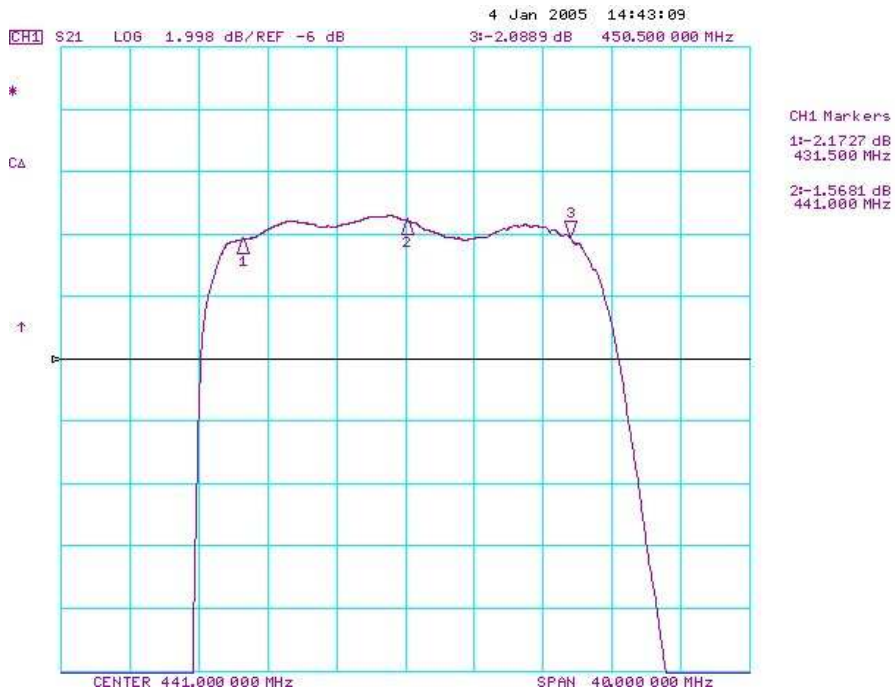

**SAW Filter 441.0MHz**  
**Part No: MA07507**

**Model: TA0419A**  
**Rev No: 1**

**D. MEASUREMENT CIRCUIT:**

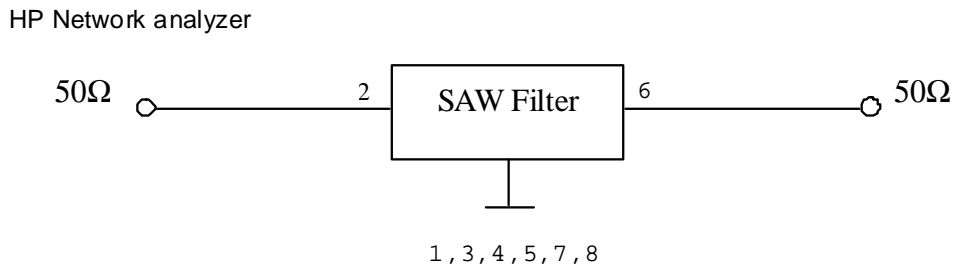

**E. OUTLINE DRAWING:**

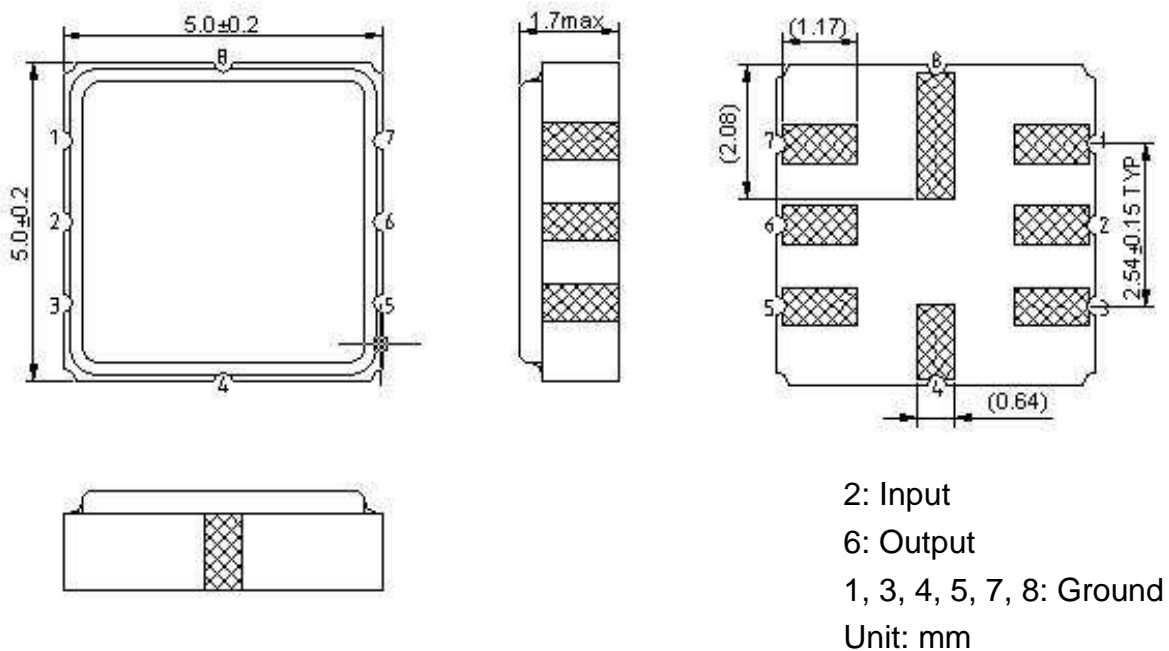

**F. PCB FOOTPRINT:**

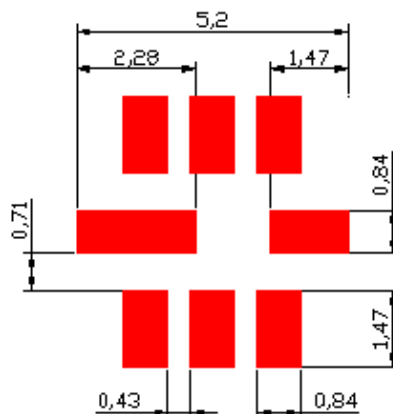

**SAW Filter 441.0MHz**  
**Part No: MA07507**

**Model: TA0419A**  
**Rev No: 1**

**G. PACKING:**

**1. REEL DIMENSION**

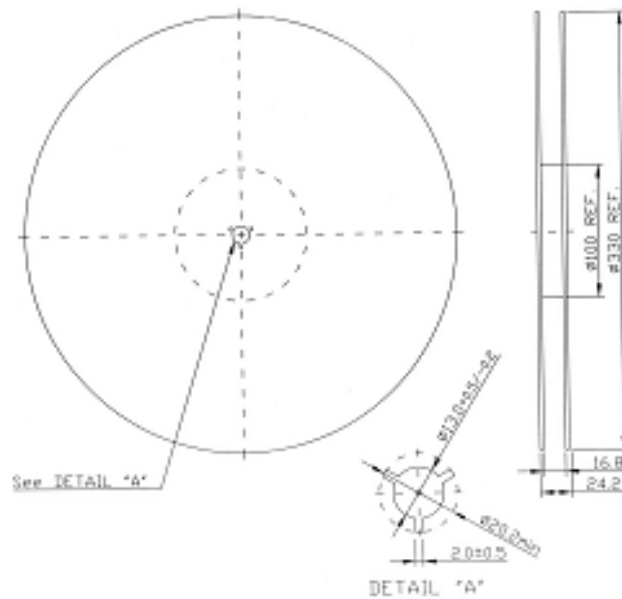

**2. TAPE DIMENSION**

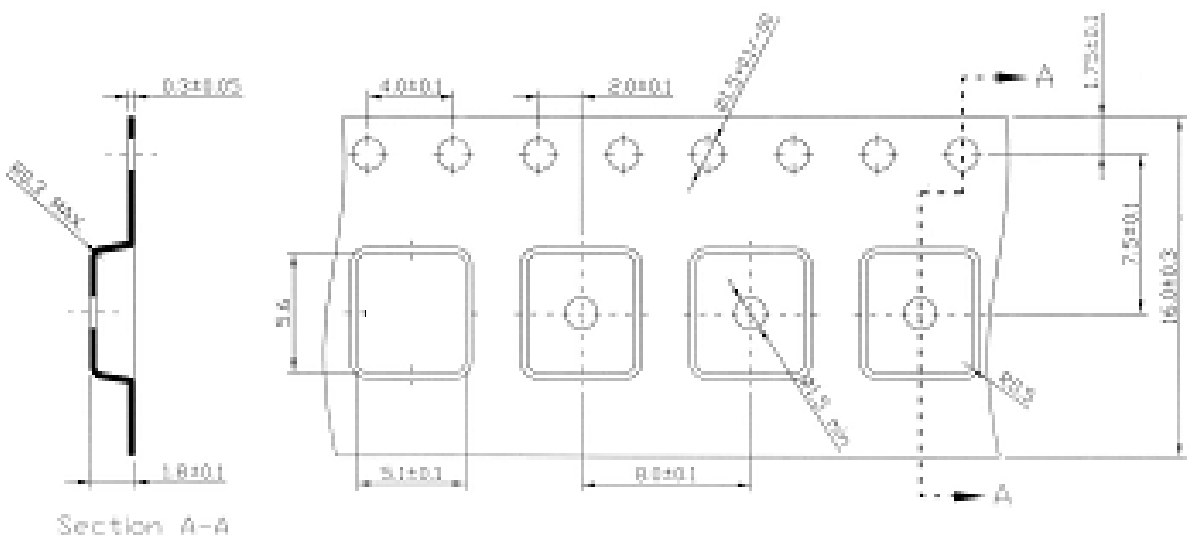

Direction of Feed

