

SSB Applications	Model Number	Centre Frequency (MHz)	Number of Poles	Pass Band dB @ kHz	Attenuation Band dB @ kHz		In-Band Ripple (dB)	Insertion Loss (dB)	Guaranteed Attenuation (dB @ kHz)		Termination ( $\Omega$ /pF)	Package Style	
	8G22D	8.700	8	6 $\pm$ 1.1	60	$\pm$ 2.4		2.0	6.0	80	$\pm$ 10.0 $\sim$ $\pm$ 40.0	1000 // 15	F23/12B
	9G22C	9.000	6	6 $\pm$ 1.1	60	$\pm$ 3.0		2.0	4.0	80	$\pm$ 10.0 $\sim$ $\pm$ 40.0	700 // 18	F18/12P
	9G22D	9.000	8	6 $\pm$ 1.1	60	$\pm$ 2.4		2.0	6.0	80	$\pm$ 10.0 $\sim$ $\pm$ 40.0	700 // 18	F23/12B
	9G24F	9.000	12	6 $\pm$ 1.2	60	$\pm$ 1.9		2.0	6.0	90	$\pm$ 10.0 $\sim$ $\pm$ 40.0	1000 // 7	F38/12A
	10G22D	10.6935	8	6 $\pm$ 1.1	20	$\pm$ 1.5	60 $\pm$ 2.4	2.0	5.0			600 // 15	F36/10A
	10G22D	10.700	8	6 $\pm$ 1.1	60	$\pm$ 2.4		2.0	6.0	80	$\pm$ 10.0 $\sim$ $\pm$ 40.0	500 // 18	F23/12B
	14G22C	14.000	6	6 $\pm$ 1.1	60	$\pm$ 3.0		2.0	6.0	80	$\pm$ 10.0 $\sim$ $\pm$ 40.0	470 // 15	F18/12P
	14G22D	14.000	8	6 $\pm$ 1.1	60	$\pm$ 2.4		2.0	6.0	80	$\pm$ 10.0 $\sim$ $\pm$ 40.0	470 // 15	F23/12B

General Applications	Model Number	Centre Frequency (MHz)	Number of Poles	Pass Band dB @ kHz	Attenuation Band dB @ kHz		In-Band Ripple (dB)	Insertion Loss (dB)	Guaranteed Attenuation (dB @ kHz)		Termination ( $\Omega$ // pF)	Package Style
	9G4C	9.000	6	6 $\pm$ 2.0	60	$\pm$ 7.0	2.0	6.0	65	+350 $\sim$ +1000 85 -200 $\sim$ -1000	700 // 18	F38/12A
	9G6A	9.000	2	3 $\pm$ 3.0	18	$\pm$ 12.5	0.5	1.5	35	+350 $\sim$ +1000 50 -200 $\sim$ -1000	2000 // 5.0	HC49/3L
	9G6B	9.000	4	3 $\pm$ 3.0	40	$\pm$ 10.0	1.0	2.0	65	+350 $\sim$ +1000 80 -200 $\sim$ -1000	2000 // 4.0	HC49/3Lx2
	9G6C	9.000	6	3 $\pm$ 3.0	60	$\pm$ 7.5	2.0	6.0	65	+350 $\sim$ +1000 80 -200 $\sim$ -1000	700 // 18	
	9G15A	9.000	2	3 $\pm$ 7.5	18	$\pm$ 25.0	1.0	2.0	35	+350 $\sim$ +1000 50 -200 $\sim$ -1000	3900	HC49/3L
	9G15B	9.000	4	3 $\pm$ 7.5	40	$\pm$ 25.0	1.0	2.5	65	+350 $\sim$ +1000 80 -200 $\sim$ -1000	3900	HC49/3Lx2
	9G20A	9.000	2	3 $\pm$ 10.0	18	$\pm$ 34.0	1.5	4.0	35	+350 $\sim$ +1000 50 -200 $\sim$ -1000	5600	HC49/3L
	10G4C	10.700	6	6 $\pm$ 2.0	60	$\pm$ 6.5	2.0	4.0	65	+350 $\sim$ +1000 80 -200 $\sim$ -1000	1200 // 7.0	F18/12P
	10G4D	10.700	8	6 $\pm$ 2.0	60	$\pm$ 5.0	2.0	6.0	90	$\pm$ 200 $\sim$ $\pm$ 1000	910 // 10.0	F23/12B
	10G6A	10.700	2	3 $\pm$ 3.0	18	$\pm$ 12.5	0.5	2.0	35	+350 $\sim$ +1000 50 -200 $\sim$ -1000	1200 // 5.0	HC49/3L
	10G6B	10.700	4	3 $\pm$ 3.0	40	$\pm$ 10.0	1.0	2.5	65	+350 $\sim$ +1000 80 -200 $\sim$ -1000	1200 // 5.0	HC49/3Lx2
	10G6C	10.700	6	3 $\pm$ 3.0	40	$\pm$ 6.0	2.0	4.0	65	+350 $\sim$ +1000 80 -200 $\sim$ -1000	1200 // 5.0	F18/12P
	10G10A	10.700	2	3 $\pm$ 5.0	20	$\pm$ 20.0	0.5	1.5	35	+350 $\sim$ +1000 50 -200 $\sim$ -1000	2000	HC49/3L
	10G10B	10.700	4	3 $\pm$ 5.0	40	$\pm$ 17.5	1.5	2.5	65	+350 $\sim$ +1000 80 -200 $\sim$ -1000	2000 // 3.0	HC49/3Lx2
10G13D	10.700	8	6 $\pm$ 6.5	60	$\pm$ 14.0	2.0	4.0	90	$\pm$ 200 $\sim$ $\pm$ 1000	3100	F23/12B	

10.7MHz	Model Number	Centre Frequency (MHz)	Number of Poles	Pass Band dB @ kHz	Attenuation Band dB @ kHz		In-Band Ripple (dB)	Insertion Loss (dB)	Guaranteed Attenuation (dB @ kHz)		Termination ( $\Omega$ // pF)	Package Style	
	X10G7D1	10.700	8	3 $\pm$ 3.75	70	$\pm$ 8.75	90 $\pm$ 12.5	2.0	4.0	90	$\pm$ 12.5 $\sim$ $\pm$ 300	910 // 25.0	F38/18E
	X10G7D2	10.700	8	3 $\pm$ 3.75	70	$\pm$ 8.75	90 $\pm$ 12.5	2.0	4.0	90	$\pm$ 12.5 $\sim$ $\pm$ 300	910 // 25.0	F38/18F
	X10G12D1	10.700	8	3 $\pm$ 6.0	70	$\pm$ 14.0	90 $\pm$ 20.0	2.0	3.5	90	$\pm$ 20.0 $\sim$ $\pm$ 300	910 // 25.0	F38/18E
	X10G12D2	10.700	8	3 $\pm$ 6.0	70	$\pm$ 14.0	90 $\pm$ 20.0	2.0	3.5	90	$\pm$ 20.0 $\sim$ $\pm$ 300	910 // 25.0	F38/18F
	X10G15D1	10.700	8	3 $\pm$ 7.5	70	$\pm$ 17.5	90 $\pm$ 25.0	2.0	3.5	90	$\pm$ 25.0 $\sim$ $\pm$ 300	910 // 25.0	F38/18E
	X10G15D2	10.700	8	3 $\pm$ 7.5	70	$\pm$ 17.5	90 $\pm$ 25.0	2.0	3.5	90	$\pm$ 25.0 $\sim$ $\pm$ 300	910 // 25.0	F38/18F

21.4MHz	Model Number	Centre Frequency (MHz)	Number of Poles	Pass Band dB @ kHz	Attenuation Band dB @ kHz		In-Band Ripple (dB)	Insertion Loss (dB)	Guaranteed Attenuation (dB @ kHz)		Termination ( $\Omega$ // pF)	Package Style	
	X21G7D1	21.400	8	3 $\pm$ 3.75	70	$\pm$ 9.0	90 $\pm$ 12.5	2.0	4.0	90	$\pm$ 12.5 $\sim$ $\pm$ 300	910 // 15.0	F38/18E
	X21G7D2	21.400	8	3 $\pm$ 3.75	70	$\pm$ 9.0	90 $\pm$ 12.5	2.0	4.0	90	$\pm$ 12.5 $\sim$ $\pm$ 300	910 // 15.0	F38/18F
	X21G7DA	21.400	8	3 $\pm$ 3.75	65	$\pm$ 9.0	90 $\pm$ 12.5	2.0	4.5	90	$\pm$ 12.5 $\sim$ $\pm$ 300	470 // 15.0	F25/14B
	X21G12D1	21.400	8	3 $\pm$ 6.0	70	$\pm$ 14.0	90 $\pm$ 20.0	2.0	3.5	90	$\pm$ 20.0 $\sim$ $\pm$ 300	910 // 15.0	F38/18E
	X21G12D2	21.400	8	3 $\pm$ 6.0	70	$\pm$ 14.0	90 $\pm$ 20.0	2.0	3.5	90	$\pm$ 20.0 $\sim$ $\pm$ 300	910 // 15.0	F38/18F
	X21G12DA	21.400	8	3 $\pm$ 6.0	65	$\pm$ 14.0	90 $\pm$ 20.0	2.0	4.0	90	$\pm$ 20.0 $\sim$ $\pm$ 300	470 // 15.0	F25/14B
	X21G15D1	21.400	8	3 $\pm$ 7.5	70	$\pm$ 17.5	90 $\pm$ 25.0	2.0	3.5	90	$\pm$ 25.0 $\sim$ $\pm$ 300	910 // 15.0	F38/18E
	X21G15D2	21.400	8	3 $\pm$ 7.5	70	$\pm$ 17.5	90 $\pm$ 25.0	2.0	3.5	90	$\pm$ 25.0 $\sim$ $\pm$ 300	910 // 15.0	F38/18F
	X21G15DA	21.400	8	3 $\pm$ 7.5	65	$\pm$ 17.5	90 $\pm$ 25.0	2.0	4.0	90	$\pm$ 25.0 $\sim$ $\pm$ 300	470 // 15.0	F25/14B

## UM-1/3L, UM-4/3L & UM-5/3L

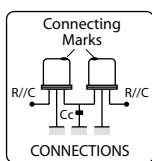
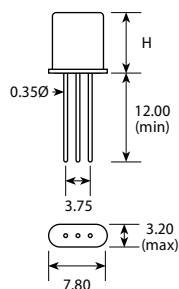

Package	Height H
UM-1/3L	8.00 max
UM-4/3L	4.80 max
UM-5/3L	6.00 max

UM-1/3Lx2 is a pair of UM-1/3Ls connected as shown.

Scale 1:1

## HC49/3L & HC49T/3L

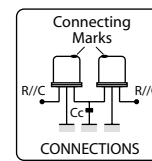
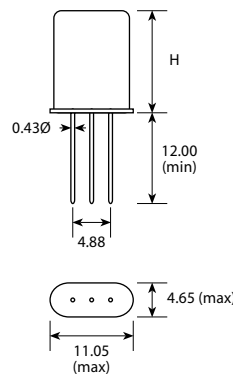
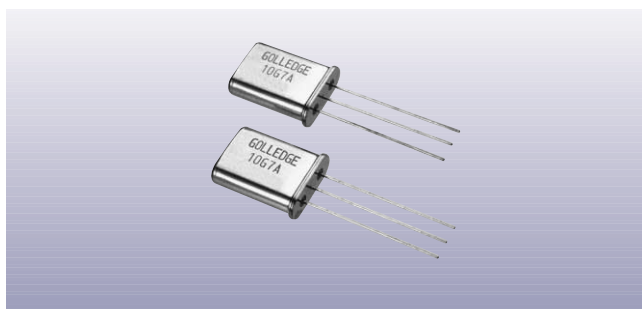

Package	Height H
HC49	13.46 max
HC49T	11.70 max

HC49/3Lx2 is a pair of HC49/3Ls connected as shown.

Scale 1:1

## UM-1JN/3L, UM-4JN/3L & UM-5JN/3L

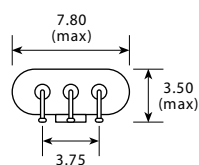
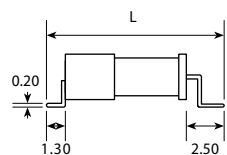
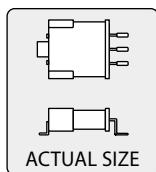
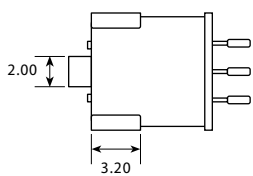
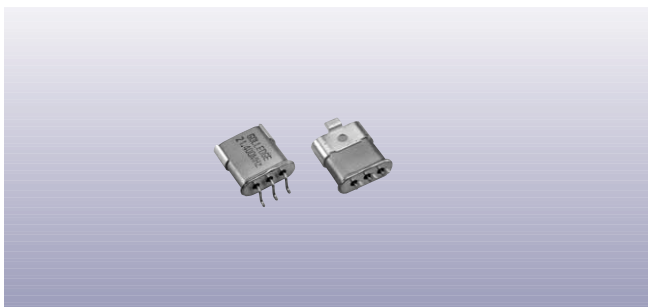

Package	Length L
UM-1JN/3L	12.50 max
UM-4JN/3L	9.30 max
UM-5JN/3L	10.50 max

Scale 2:1

## UM-1JC/3L, UM-4JC/3L & UM-5JC/3L

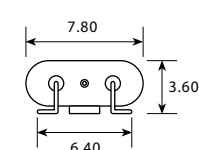
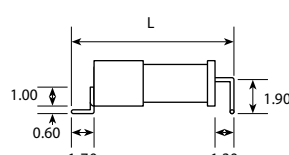
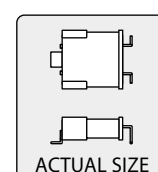
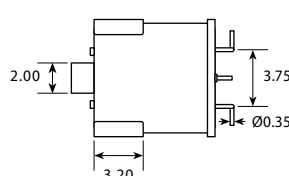
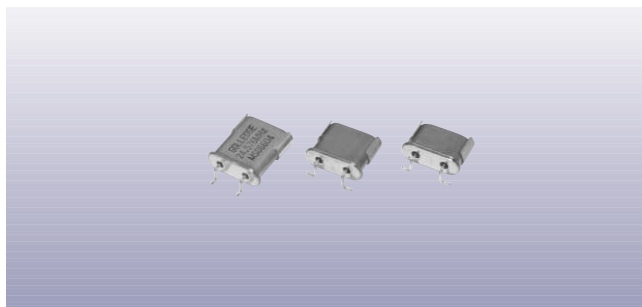

Package	Length L
UM-1JC/3L	11.10 max
UM-4JC/3L	7.80 max
UM-5JC/3L	9.00 max

Scale 2:1

## F11/8A

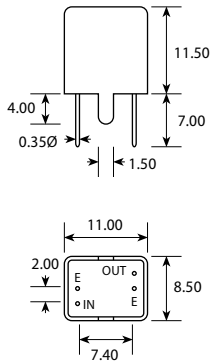
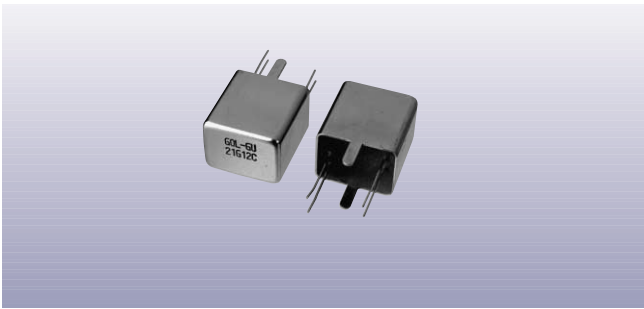

Scale 1:1

## F13/8A

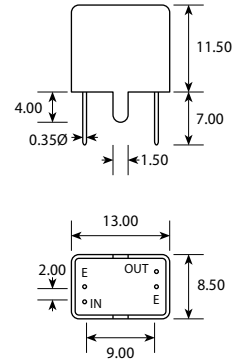
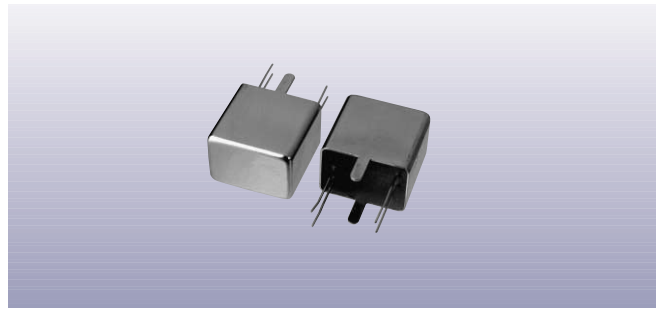

Scale 1:1

## F15/12B

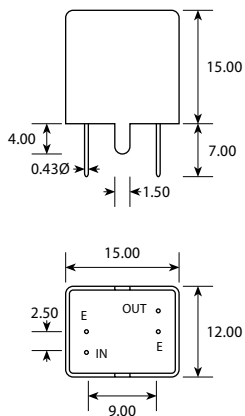
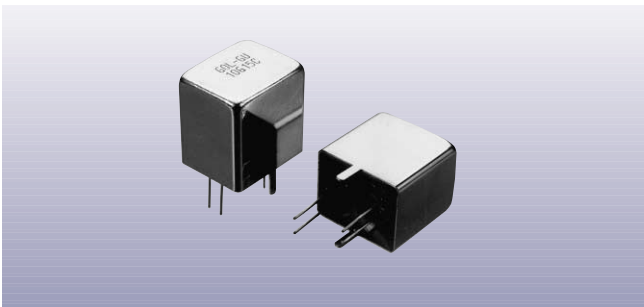

Scale 1:1

## F18/12P

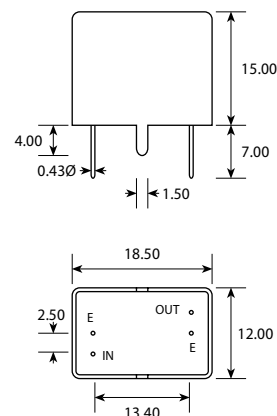
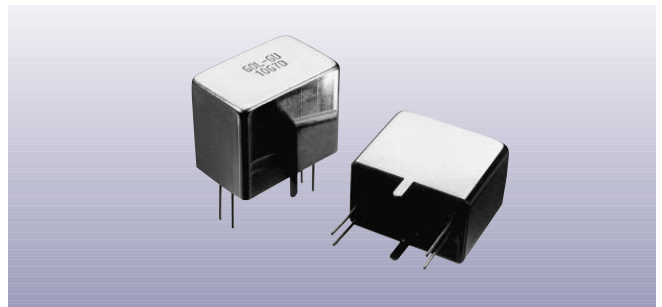

Scale 1:1

## F23/12B

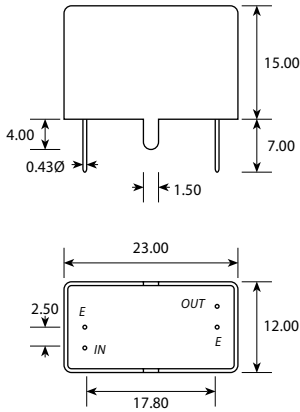
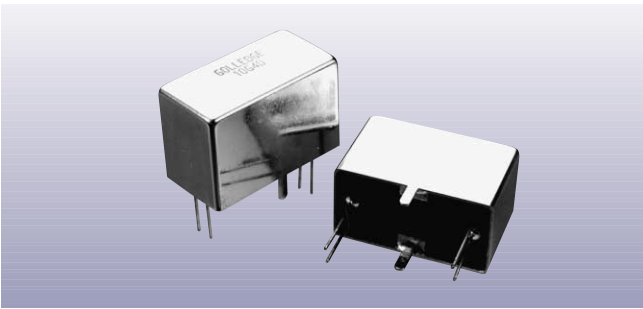

Scale 1:1

## F25/14B

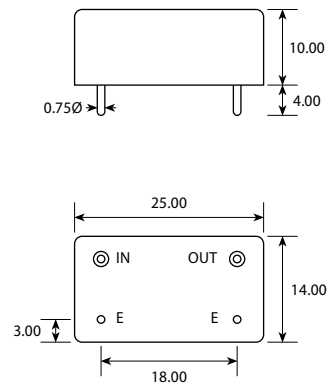
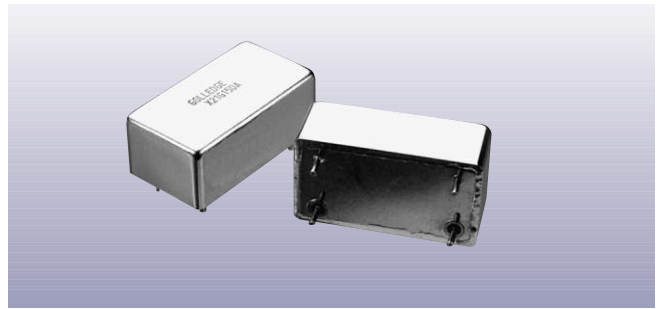

Scale 1:1

## F36/27M

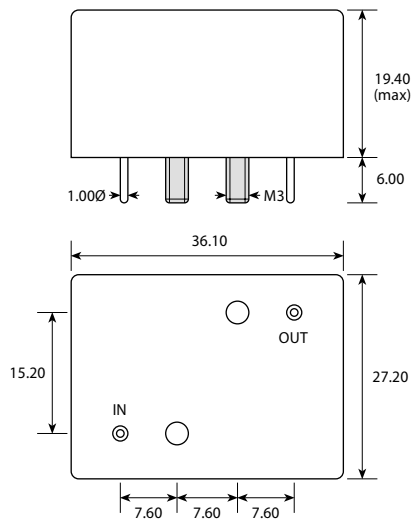

Scale 1:1

## F38/12A

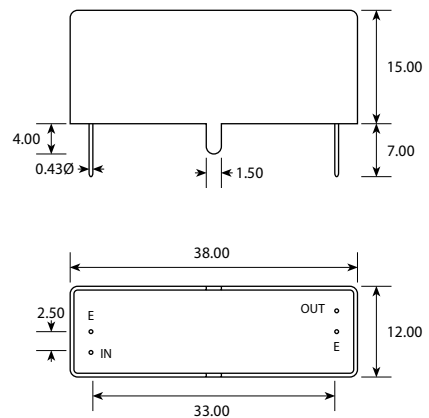

Scale 1:1

## F38/18E

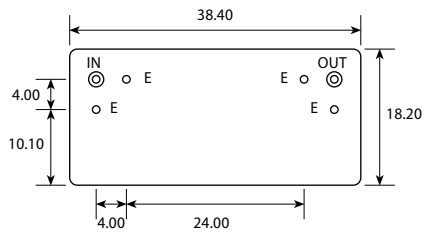
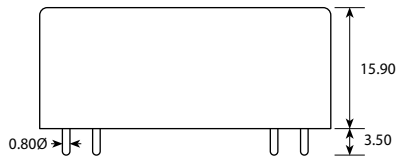
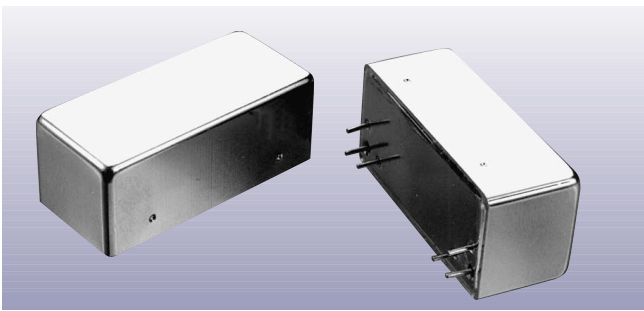

Scale 1:1

## F38/18F

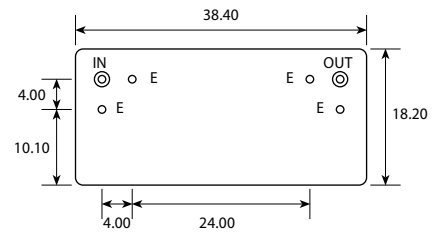
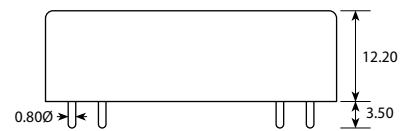
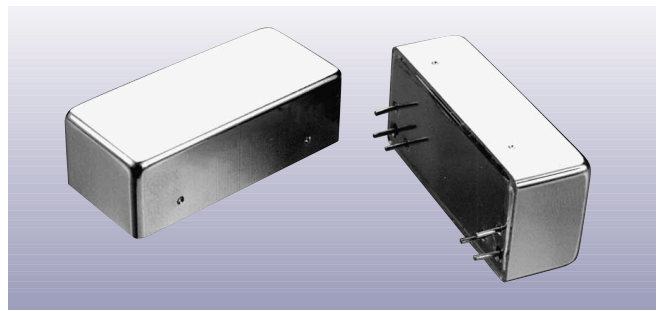

Scale 1:1