

Product Description

Description:	48.0MHz GXO-3201G/E SM Oscillator
Product family:	GXO-3201
Category:	SM Oscillator
Order code:	MP04603

Features

- ▶ Low current consumption
- ▶ Enable / disable tristate function
- ▶ Miniature ceramic package with metal lid
- ▶ Competitive pricing

Additional Information

For further information regarding packaging, construction, material composition, soldering profile and environment, please refer to **GXO-3201 Product Information sheet**

For dimensions, refer to package drawing: **D0290-A**

Electrical Specifications

Parameter	Value	Notes
Nominal frequency:	48.0MHz	
Frequency stability:	±30ppm max	Frequency stability is inclusive of calibration @25°C, operating temperature range, supply voltage change, load change, shock & vibration.
Operating temperature range:	-20 to +70°C	
Storage temperature range:	-55 to +100°C	
Supply voltage (V _{DD}):	+1.8V	±5%
Supply current:	3.5mA max	
Rise/fall time:	10ns max	
Enable/disable times:	10ms/200ns	
Driving ability:	15pF CMOS	
Logic levels:	'0' level = 10%V _{DD} max '1' level = 90%V _{DD} min	
Waveform symmetry:	40:60%	@50% V _{DD}
Start-up time:	10ms max	
Ageing:	±5ppm max	Per year
Period jitter (RMS):	5ps max	
Phase jitter (RMS):	1ps max	12kHz ~ 20MHz

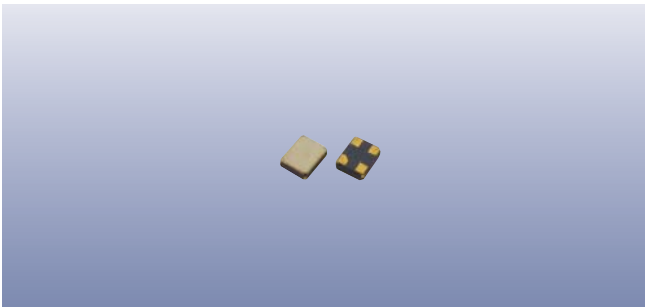

Construction

- ▣ Ceramic body with gold-plated pads
- ▣ Metal lid, seam sealed

Composition



This product is lead-free, and is fully compliant with the RoHS 2 directive 2011/65/EU



Packaging & Handling

Production quantities supplied on T&R, 1k or 3k pcs per reel. Small quantities may be supplied on tape (no reel), or in bulk.



♦ Static sensitive product. Observe proper handling precautions

Marking

FREQUENCY
S DC

Marking type: Laser
DC = Date code in YM, eg "CE" = May 2013

	A	B	C	D	E	F	G	H	J	K	L	M
Y	1	2	3	4	5	6	7	8	9	0		
M	Jan	Feb	Mar	Apr	May	Jun	Jul	Aug	Sep	Oct	Nov	Dec

Tape & Reel Specification

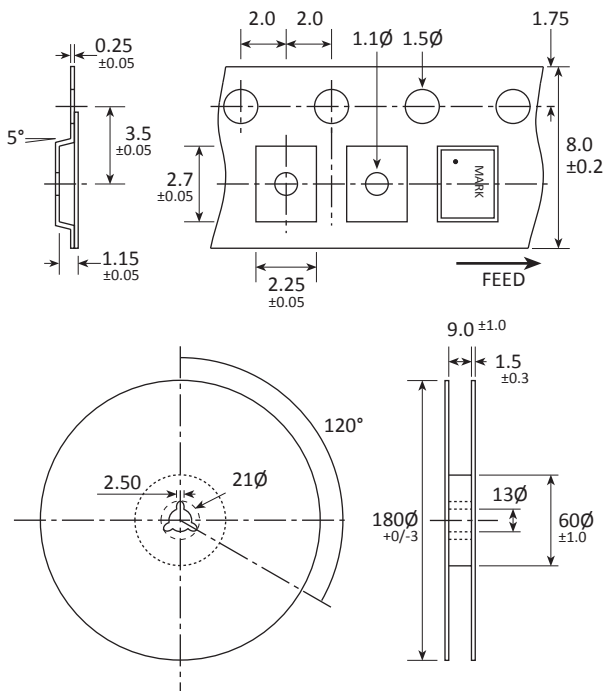

Not to scale. Dimensions in mm. Tolerances ±0.1mm unless otherwise stated.

Soldering Profile

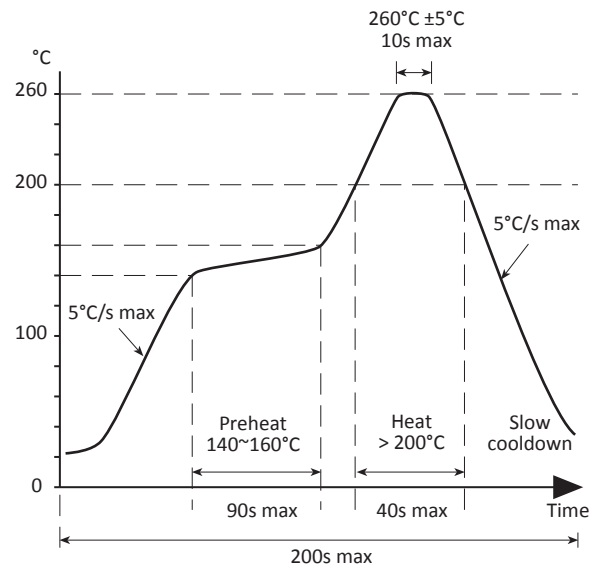

Solder resistance: 260°C x 10 secs x 2.

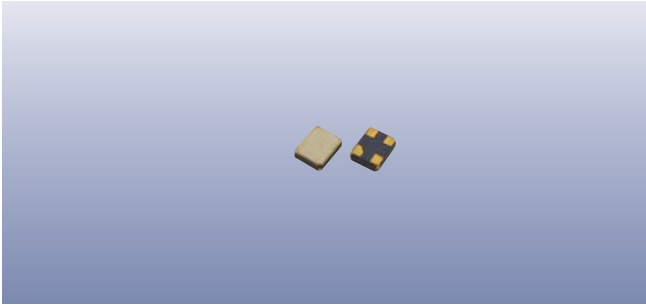

Product Family

GAO-3201, GXO-3201, GXO-3203

Construction

- ▮ Ceramic body with gold-plated pads
- ▮ Metal lid, seam sealed

Dimensions (mm)

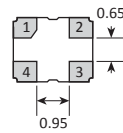
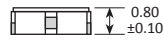
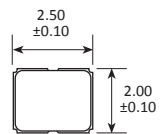

SOLDER PAD LAYOUT

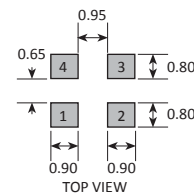

PAD	CONNECTION
1	Enable/Disable
2	Ground
3	Output
4	Supply